



# CNC FAGOR *8055 plus*

# Ideal for large production lines and for unitary parts applications

**FAGOR AUTOMATION** has been developing automation and control systems for machine tools and manufacturing CNC's, servo drives, motors and feedback systems for over 25 years.

The **continuous evolution** of the 8055 CNC family contributes to the productivity increase, improving the efficiency of the machines in sectors requiring a robust, versatile and easy-to-install CNC system.

This CNC is widely present in applications of large production lines as well as in applications for unitary parts in a shop because the operator can use at any time either the **ISO programming** system or the Fagor **conversational programming** system.



## CNC 8055

### Central unit

- Frames with a power supply for 3 or 6 modules.
- The CPU and axes modules are part of all configurations.
- The I/O modules, SERCOS and the CPU-turbo cards are optional.

### CPU module

- Up to 1Mb of user RAM memory.
- Compact flash of up to 2 Gb (optional) with flash memory to store user programs, OEM programs, PLC programs, customizing programs, parameter tables, etc.
- Ethernet (optional). TCP-IP protocol.
- Sercos interface (optional). For digital communication through fiber optics between the FAGOR 8055 CNC and FAGOR digital servo drives (AXD/SPD).
- CAN interface (optional) for digital communication between the FAGOR 8055 CNC and FAGOR digital servo drives.

### Axis modules

- **Complete module for analog solution**  
With 4 analog inputs and 8 analog outputs, 1 probe input, 8 feedback inputs and 40 PLC digital inputs / 24 PLC digital outputs (24 V DC 150 mA, opto-coupled).
- **Half module for digital solution**  
With 4 analog inputs and 8 analog outputs, 1 probe input, 8 feedback inputs and 40 PLC digital inputs / 24 PLC digital outputs (24 V DC 150 mA, opto-coupled).

### Optional cards

- **CPU TURBO card**  
Additional 32-bit processor with math co-processor. It closes the position loop and interpolation of the axes increasing the system's power by improving block processing time.

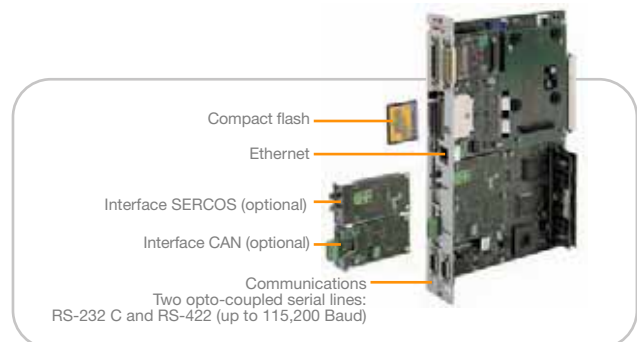
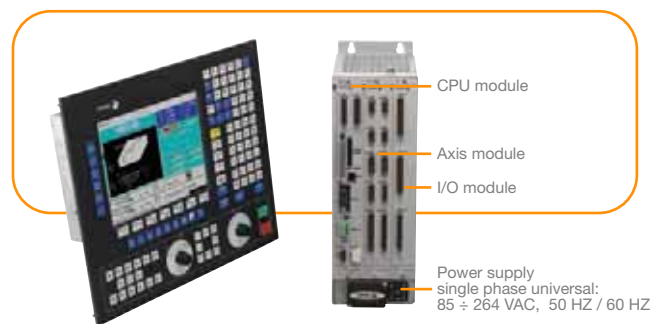

### Optional modules

- **I/O module**  
It is used to expand the basic configuration increasing the number of PLC digital inputs and outputs.  
Up to five I/O modules are possible and each offers 64 inputs and 32 outputs (24 Vdc, 150 mA) all digital and opto-coupled.
- **SERCOS module**  
For digital communication through fiber optics between the FAGOR 8055 CNC and FAGOR digital servo drives (AXD / SPD). It must be used when having the CPU-turbo card.

FAGOR CNC's are **user friendly** and permit editing a program while executing another one. They have a profile editor with graphic support to draw contours by entering known measurements off the blue-print.

Controlling position, velocity, accelerations and collisions prevents undesired machining and help achieve unmatched part-finish and maximum performance of the machine.

The tool inspection feature makes the operator's job easier by allowing him to interrupt the program, check the tool condition, replace it if necessary, reposition the axes and then resume the execution of the program.

The 8055 CNC can govern up to 7 axes and 2 spindles. Block processing time of 1.5 ms may be obtained with it, it analyzes the tool path 75 blocks in advance (look ahead) and it allows smoothing the tool path by applying the right acceleration control (Jerk control).

There are integrated models, 8055i CNC, whose CPU is integrated with the monitor and modular models, 8055 CNC, whose CPU is installed in the electrical cabinet. All models may be for lathes or for milling machines and can communicate in an analog and/or digital way with FAGOR servo systems.



## CNC 8055-*i*

### Basic configuration

- Up to 1Mb of user RAM memory.
- Compact flash of up to 2 Gb (optional) with flash memory to store user programs, OEM programs, PLC programs, customizing programs, parameter tables, etc.
- USB connector for backup of programs, parameters and tables.
- Ethernet (optional). TCP-IP protocol.
- Opto-coupled RS-232 serial line (115,200 baud).
- Feedback inputs for 2 electronic handwheels.
- Interface for 2 probes.
- PLC's opto-coupled digital I/O: 16 inputs and 8 outputs (24 V DC, 150 mA).
- Optional expansion of opto-coupled digital PLC I/O: 40 inputs and 24 outputs (24 V DC, 150 mA).
- Feedback input and analog output for the spindle.
- Optional analog expansion of 4 feedback inputs of 1 Vpp/TTL and 4 analog outputs.

### Digital solution

- SERCOS interface (optional). For digital communication through fiber optics between the FAGOR 8055i CNC and FAGOR digital servo drives (AXD/SPD).
- CAN interface (optional) for digital communication between the FAGOR 8055i CNC and FAGOR digital servo drives.

### Remote modules (I/O)

- CAN interface (optional) to communicate with the Remote I/O modules.
- Up to 288 inputs and 192 outputs in groups of 24I/16O, 48I/32O and 72I/48O. The inputs are of 24 V DC - 7 mA and the outputs of 24 V DC - 500 mA. Terminal connection.
- Remote module with 4 analog inputs, 4 analog outputs and 2 inputs for temperature gages. PT100.

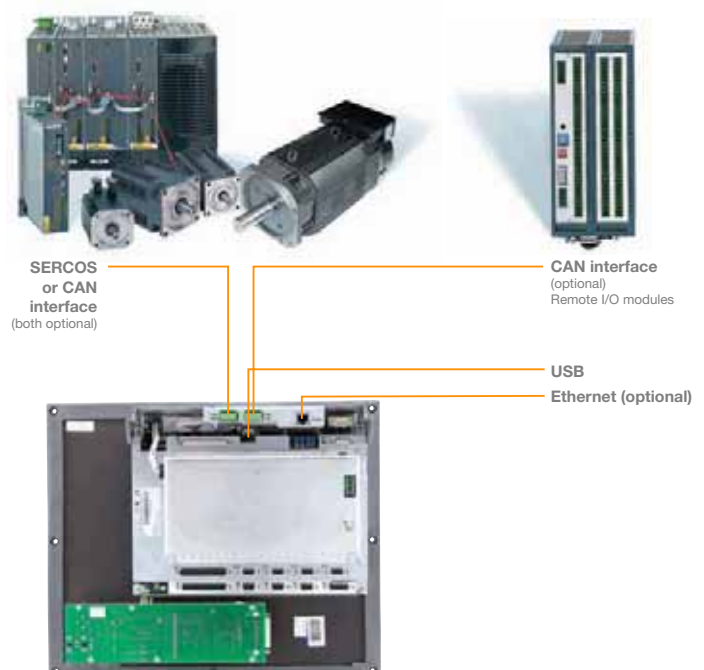

# CNC 8055 M/MC

## For Milling Machines and Machining Centers

The CNC 8055 M (ISO) and CNC 8055 MC (ISO and Conversational) models are especially designed to work on milling machines and machining centers, both horizontal and vertical.

Thanks to their features, they help improve the productivity of the processes achieving significant machining time reduction, improved part finish as well as considerable setup and training time reduction.



### Kinematics management

It is possible to select a typical kinematics and customize it to better adapt to the requirements of the machine.

It admits spherical, orthogonal and angular spindles; rotary tables and the combination of swinging spindles and rotary tables.

### Tool calibration and measuring cycles

They are simple and intuitive operations that make the operator's job easier using help graphics. In the tool calibration cycle, both manual and automatic, one just needs to set the dimensions of the master part, select the tool to be calibrated and touch the part with it. The CNC picks up the actual tool dimensions and updates its internal tables for later machining operations.

By using probes placed on the tool holder spindle, the part measuring and aligning cycles help adapt easily and automatically the work coordinates to the actual part position (hole centering, corner and angle measuring, etc.).



### 5-axis machining (RTCP)

The RTCP (Rotation Tool Center Point) function improves part finish by making the tool tip follow the programmed profile regardless of the length and orientation of the tool.

When working with RTCP and changing the orientation of the tool, the CNC moves the X, Y, Z axes to maintain the position of the tool tip on the part.

Using RTCP and the Tangential control function, it is possible to machine a profile in the plane maintaining the cutting angle of the cutter (tool position with respect to the programmed tool path) at all times.





## Editing and simulation

The capability of editing part-programs while executing another program reduces waiting time between parts. Likewise, simulating the program graphically before machining the part permits verifying each operation and correct the data entered.

## Improved production process

The Ethernet connection helps improve the production process by transmitting part-programs, previously created in the Programming Office, to the CNC for their execution.

It is also possible to monitor the machining time for statistical calculation, dead time, usage of each tool, etc.

## Possibility of production estimate

The simulation permits checking programs by graphically showing its execution. It also makes an estimate of the total execution time and of the machining time for each tool.

## Working with CAD-CAM

For those who use CAD-CAM programming, the 8055 CNC converts and executes, using the WINDNC application, tool-path files and profiles generated in DXF format.

## Startup assistance

The PLC's logic analyzer is a tool to assist you when adjusting the PLC program. It captures data at the beginning of each PLC cycle and shows the status of the requested resources.

The oscilloscope function is a tool to assist you when adjusting the axes. Up to 4 variables may be shown simultaneously and manipulate CNC, PLC and drive machine parameters and variables.

The circularity (roundness) test helps improve the axis reversal peak. It consists in machining a circle, graphically compare the theoretical path with the actual path and manipulate machine parameters until the desired result is achieved.

## Intelligent profile editor

Blueprints not always show the coordinates of the starting and end points of each section. Sometimes it suffices to just indicate the inclination angle of a section and other times, it is enough to indicate that it is tangent to the previous section.

With the Intelligent Profile Editor no calculations are required, just enter the known data into the CNC. When there are more than one solution, all possible solutions are shown graphically so the operator can select the right one.

# CNC 8055 MC

Conversational Model for Milling Machines and Machining Centers

Thanks to their versatility and capability, FAGOR conversational CNC's for milling machines and machining centers offer the highest features and are incredibly user friendly.

They minimize setup time. Any operator without previous programming knowledge will be able to efficiently

attend to any possible need by simply entering the machining conditions and the geometrical data shown on the blueprint.

Although the CNC offers more than 10 working languages, all the MC screens may be translated to the operator's own language.

## Automatic operations

The automatic operations already implemented represent the main distinguishing feature of the conversational models. They have been designed to better adapt to the usual shop working methods. They correspond to each operation of the part machining process.

The keys associated with the automatic operations have a descriptive icon. All the operations have:

- Interactive graphic assistance.
- Geometry defining area.
- Areas to set the machining conditions for the roughing and finishing stages.

All the operations have several levels, or ways, to edit with their own screen. The left side of the screen shows tabs indicating the available levels and the one selected.



Unidirectional and bidirectional surface milling



Profile milling



Rectangular and circular pocket



Pockets with 2D profile



Pockets with 3D profile



Rectangular and circular boss

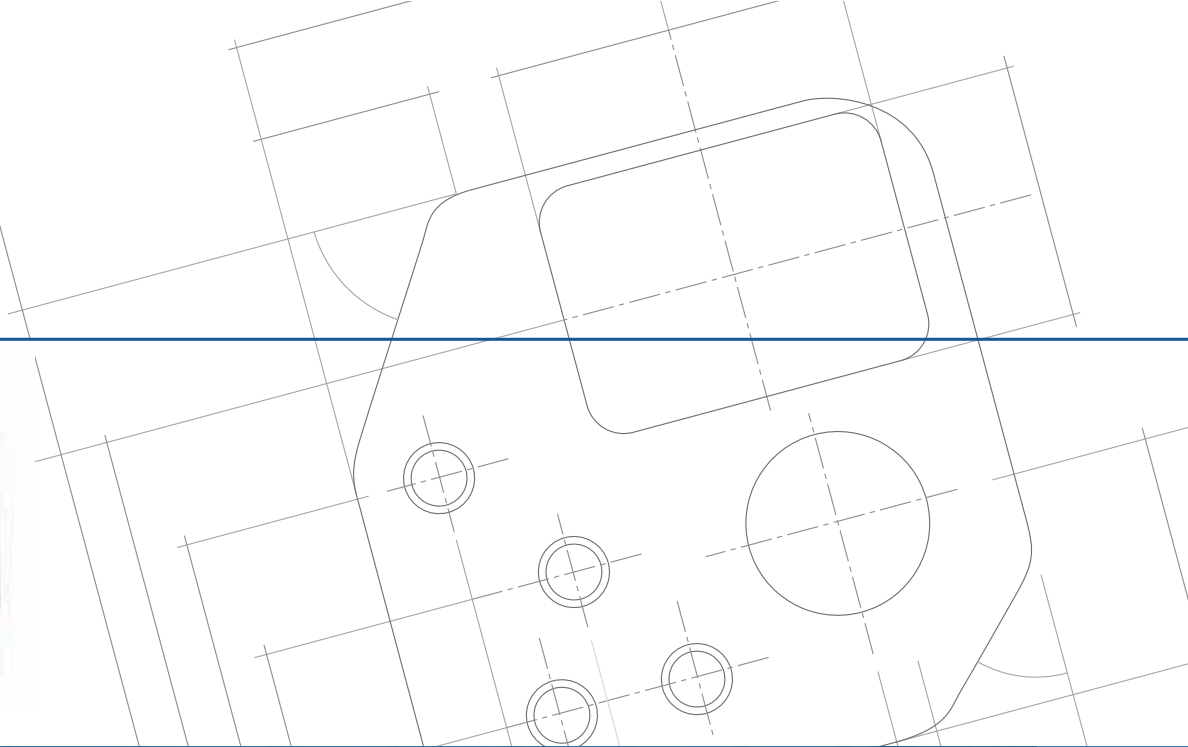

## Machining on Z

It permits easy definition of bolt-hole drilling, grid pattern tapping, pockets in an arc, etc.

Define the type of machining in Z and associate a multiply positioning to it indicating where the machining operations must be carried out.

The screen is divided into 2 areas that indicate the type of machining and its associated multiple positioning.



Drilling



Threading



Point to point positioning



Linear positioning



Arc positioning

# CNC 8055 T

## For Lathes and Turning Centers

The FAGOR 8055 CNC can control high production turning centers, vertical lathes, lathes with an incline bed and parallel lathes.

It offers functions for synchronizing axes and spindles in position and velocity. The acceleration and jerk control smooths the tool path changes and reduces mechanical stress on the components of the machine thus making them more durable.



### Extremely easy to operate in jog mode

The screen offers the operator all the necessary information (axis position and feedrate, spindle speed, selected tool, etc.).

It is possible to preset the coordinates of the axes, modify the machining conditions, select a new tool as well as start and stop the spindle, etc. The axes may be jogged with the jog keys and with handwheels.



### Changing the machining operation

With the 8055 CNC, it is very easy to change the machining on production lathes by simply transferring to the new CNC the new part-program, the offset tables for the new fixtures and automatically calibrate the new tools before machining.



### Home search

After turning the machine on, there is no need to move the axes to the reference point (home). Using FAGOR distance-coded feedback systems, the CNC assumes the new position by simply moving the axes 50 mm; with FAGOR absolute feedback systems, there is no need to move the axes.

### Tool calibration and measuring cycles

They are simple and intuitive operations that make the operator's job easier using help graphics. The tool calibration cycle helps the operator calibrate the tool easily both manually and automatically.

By using probes placed in the tool holder, the part measuring cycles help measure parts or compensate for tool wear easily and automatically.

Automatic tool calibration (cycles integrated into the part-program) provides better machining time by eliminating idle time and manual calibration.





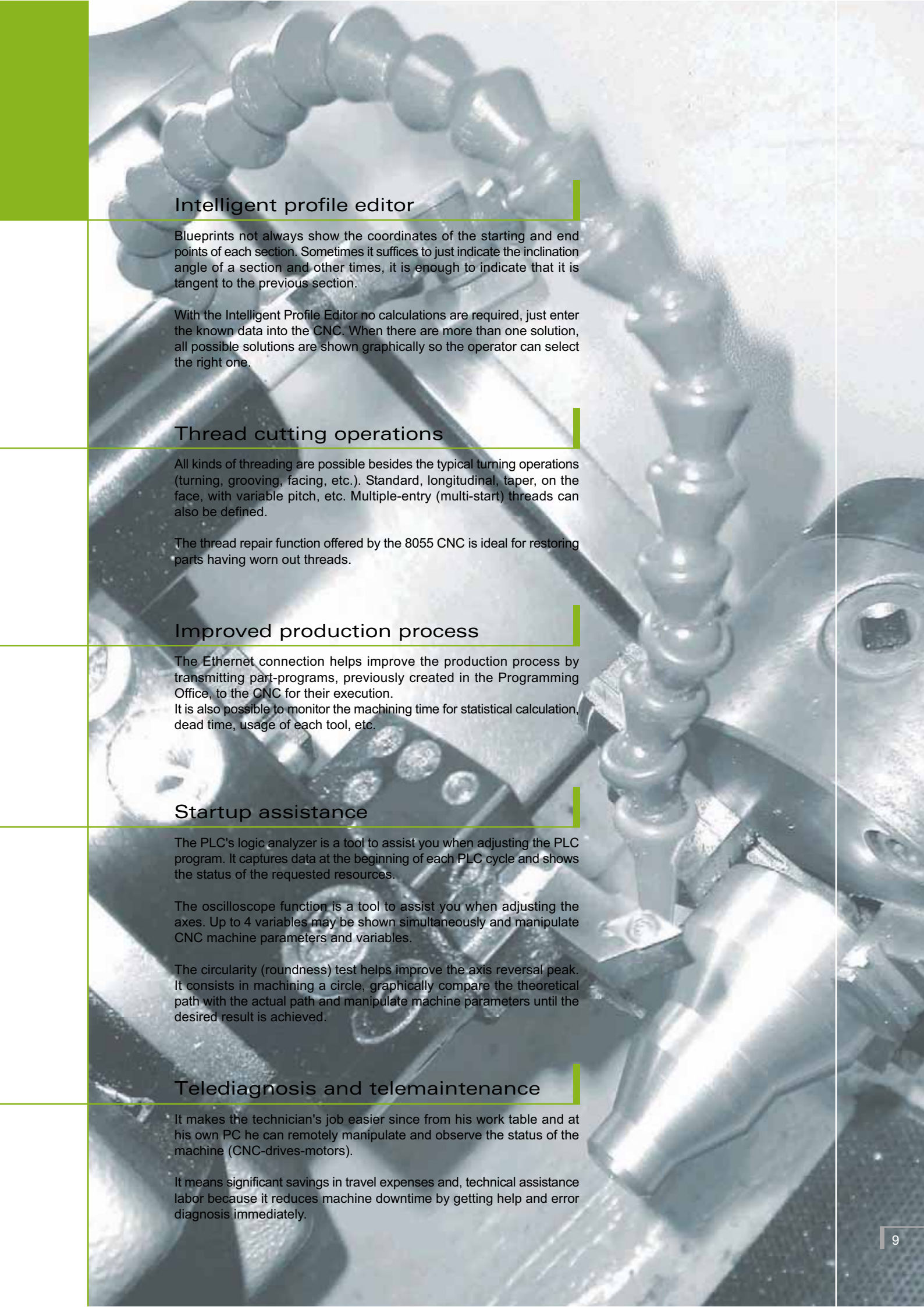

## Intelligent profile editor

Blueprints not always show the coordinates of the starting and end points of each section. Sometimes it suffices to just indicate the inclination angle of a section and other times, it is enough to indicate that it is tangent to the previous section.

With the Intelligent Profile Editor no calculations are required, just enter the known data into the CNC. When there are more than one solution, all possible solutions are shown graphically so the operator can select the right one.

## Thread cutting operations

All kinds of threading are possible besides the typical turning operations (turning, grooving, facing, etc.). Standard, longitudinal, taper, on the face, with variable pitch, etc. Multiple-entry (multi-start) threads can also be defined.

The thread repair function offered by the 8055 CNC is ideal for restoring parts having worn out threads.

## Improved production process

The Ethernet connection helps improve the production process by transmitting part-programs, previously created in the Programming Office, to the CNC for their execution.

It is also possible to monitor the machining time for statistical calculation, dead time, usage of each tool, etc.

## Startup assistance

The PLC's logic analyzer is a tool to assist you when adjusting the PLC program. It captures data at the beginning of each PLC cycle and shows the status of the requested resources.

The oscilloscope function is a tool to assist you when adjusting the axes. Up to 4 variables may be shown simultaneously and manipulate CNC machine parameters and variables.

The circularity (roundness) test helps improve the axis reversal peak. It consists in machining a circle, graphically compare the theoretical path with the actual path and manipulate machine parameters until the desired result is achieved.

## Telediagnosis and telemaintenance

It makes the technician's job easier since from his work table and at his own PC he can remotely manipulate and observe the status of the machine (CNC-drives-motors).

It means significant savings in travel expenses and, technical assistance labor because it reduces machine downtime by getting help and error diagnosis immediately.

# CNC 8055 TC

## Conversational Model for Lathes and Turning Centers



Thanks to their versatility and capability, FAGOR conversational CNC's for lathes and turning centers offer the highest features and are incredibly user friendly.

They minimize setup time. Any operator without previous programming knowledge will be able to efficiently attend to any

possible need by simply entering the machining conditions and the geometrical data shown on the blueprint.

Although the CNC offers more than 10 working languages, all the TC screens may be translated to the operator's own language.

## Automatic operations

The automatic operations already implemented represent the main distinguishing feature of the conversational models. They have been designed to better adapt to the usual shop working methods. They correspond to each operation of the part machining process.

The keys associated with the automatic operations have a descriptive icon. All the operations have:

- Interactive graphic assistance.
- Geometry defining area
- Areas to set the machining conditions for the roughing and finishing stages.

All the operations may be programmed for outside or inside machining and have several levels, or ways, to edit with their own screen. The left side of the screen shows tabs indicating the available levels and the one selected.



Turning, facing, taper, rounding



Threading



Grooving



Profiles



Grooving



Profiles

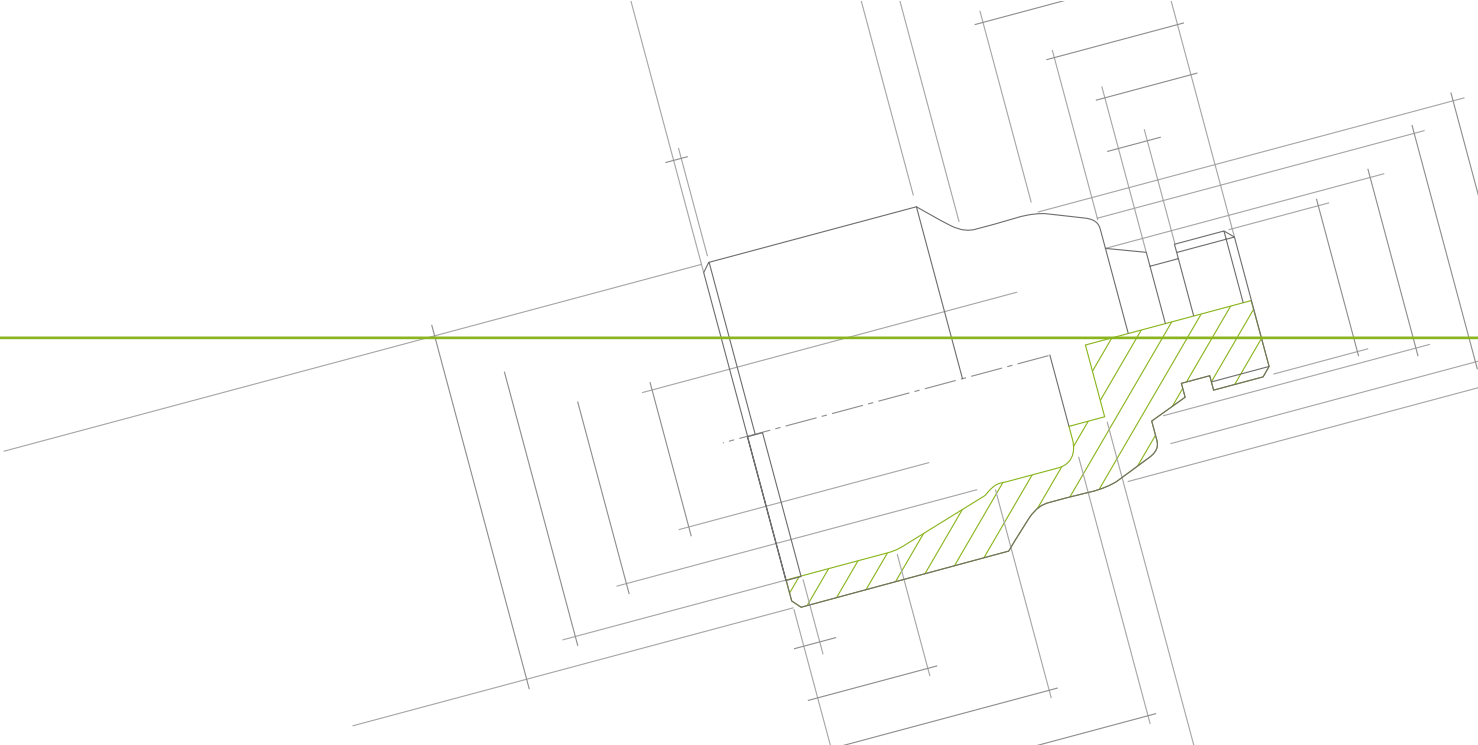

## "C" axis related automatic operations

When the machine has a C axis, it is possible to machine on the side of the part and on its face. It is also possible to run the machining operation only once or several times, multiple drilling, multiple tapping, etc.



Multiple drilling and tapping



Profiles associated with the "C" axis



Multiple slot milling



Rectangular and circular pockets associated with the C axis



# General Characteristics

CONFIGURATION	8055 / A	8055- <i>plus</i>	8055- <i>i</i> / A	8055- <i>i plus</i>
<b>Axes and spindles</b>				
Maximum axis configuration for lathe	2 ▲ 4	2 ▲ 4 ▲ 7	2 ▲ 4	2 ▲ 4 ▲ 7 (with digital interface)
Maximum axis configuration for milling	4	4 ▲ 7	4	4 ▲ 7 (with digital interface)
Maximum configuration of spindles	2		2	2
C axis	-	▲ (on 4 and 7-axis lathe)	-	▲ (on 4 and 7-axis lathe)
Maximum axis + spindle configuration (analog + spindle)	5	8	5	8
Gantry axes	●	●	●	●
Tandem axes	Only with SERCOS digital			
Axis coupling via PLC	●	●	●	●
Axis coupling via program	●	●	●	●
<b>User memory (RAM)</b>				
User memory (RAM)	256 K ▲ 1MB	1MB	256 K ▲ 1MB	1MB
Compact flash (KEYCF)	512 MB ▲ 2 GB		512 MB ▲ 2 GB	
<b>Integrated PLC</b>				
Cycle time of the PLC	3 ms / 1.000 instruc. ▲ 1 ms / 1.000 instruc.			
Direct programming in mnemonics	●	●	●	●
Logic analyzer	●	●	●	●
<b>Communication</b>				
RS 232 (up to 115.200 Bd)	●	●	●	●
RS 422	●	●	-	-
DNC (through RS232)	●	●	●	●
USB	-	-	●	●
Ethernet	▲	▲	▲	▲
Telediagnosis via modem	▲	▲	▲	▲
<b>Axis adjustment</b>				
Look-ahead.	75 blocks	75 blocks	75 blocks	75 blocks
Jerk control	●	●	●	●
Feed forward / AC forward	●	●	●	●
Oscilloscope function (setup assistance)	●	●	●	●
Circularity test (setup assistance)	●	●	●	●
<b>System architecture</b>				
Hardware configuration	Modular central unit		Central unit integrated into the monitor	
Monitor	10.4" Color VGA TFT LCD		▲ LCD TFT 10,4" color VGA ▲ 10.4" monochrome STN LCD	
Feedback inputs	8 feedback inputs for axes, spindles and handwheels		1 specific for spindle 2 specific for electronic handwheels ▲ 4 for axes, spindles or handwheels	
Feedback inputs at the drives	Requires SERCOS option		Requires SERCOS option	
Analog inputs (±10 V)	8 analog outputs for axes and spindles		1 specific for spindle ▲ 4 for axes, spindles	
Analog inputs (±5 V)	4	4	-	-
Probe inputs, 5V (0.25mA) or 24V (0.30 mA)	2	2	2	2
Local digital inputs and outputs (150 mA)	40 I / 24 O ▲ 232 I / 120 O		16 I / 8 O ▲ 56 I / 32 O	
CPU turbo	▲	▲	-	-
CAN for connection to remote modules	▲	▲	▲	▲
CAN for digital connection with the drives	▲	▲	▲	▲
SERCOS for digital connection with the drives	▲	▲	▲	▲
<b>Remote I/O modules (option)</b>				
Possible nodes (CAN Open)	-	-	4	4
Possible inputs / outputs in each node (500 mA)	-	-	72 I / 48 O	72 I / 48 O
<b>System voltage supply</b>				
Central unit	Universal AC		24 V dc	
Digital inputs and outputs	24 V dc		24 V dc	
Remote I/O modules	24 V dc		24 V dc	
<b>Servo drive systems</b>				
Analog	●	●	●	●
Digital SERCOS (for AXD / SPD drives)	▲	▲	▲	▲
Digital CAN (for ACS D / SPD drives)	▲	▲	▲	▲
<b>Models</b>				
Milling	M	M	M	M
Lathe	T	T	T	T
Conversational	milling	MC	MC	MC
	lathe	TC	TC	TC
Conversational open	milling	MCO	MCO	MCO
	lathe	TCO	TCO	TCO
General purpose	GP	GP	GP	GP

●● Standard    ▲▲ Option    - Not Available

# General Features

For Milling Machines, Machining Centers and General Purpose Machines

FEATURES	GP	M	MC	MCO
<b>Spindle related</b>				
Spindle orientation M19	-	●	●	●
<b>Interpolation</b>				
Linear, circular, helical	●	●	●	●
Tangential control	▲	▲	▲	▲
Retrace function	-	▲	▲	▲
RTCP function (only on PLUS model with 7 axes)	-	▲	▲	▲
<b>Compensations</b>				
Tool length and radius	▲	●	●	●
Tool life monitoring	-	▲	▲	▲
<b>Graphics</b>				
Tool path	●	●	●	●
3 simultaneous views (with depth simulation)	●	●	●	●
Solid graphics	-	●	●	●
<b>Operation related</b>				
Simulation with execution time estimate	●	●	●	●
Look-ahead of N blocks to avoid tool collision	●	●	●	●
<b>Programming related functions</b>				
Feedrate as an inverted function of time	●	●	●	●
Profile editor	●	●	●	●
<b>Communications related functions</b>				
Ethernet	▲	▲	▲	▲
DNC (DNC communications)	●	●	●	●
Telediagnosis	▲	▲	▲	▲
Setup assistance	●	●	●	●
<b>Canned cycles</b>				
Machining canned cycles	-	●	●	-
Multiple-positioning canned cycles	-	●	●	-
Probing canned cycles	-	▲	▲	▲
Digitizing (only on PLUS model)	-	▲	▲	▲
Irregular pockets with islands	-	●	●	●
Rigid Tapping	▲	▲	▲	▲

For Lathes and Turning Centers

FEATURES	T	TC	TCO
<b>Spindle related</b>			
Spindle orientation M19	●	●	●
Spindle synchronization	●	●	●
<b>Interpolation</b>			
Linear, circular, helical	●	●	●
Tangential control	▲	▲	▲
Retrace function	▲	▲	▲
C axis. (only on PLUS model with 7 axes)	▲	▲	▲
Y axis for lathe (only on PLUS model with 7 axes)	▲	▲	▲
<b>Compensations</b>			
Tool length and radius	●	●	●
Tool geometry	●	●	●
Tool life monitoring	▲	▲	▲
<b>Graphics</b>			
Tool path	●	●	●
Solid graphics	●	●	●
<b>Operation related</b>			
Simulation with execution time estimate	●	●	●
Look-ahead of N blocks to avoid tool collision	●	●	●
<b>Programming related functions</b>			
Feedrate as an inverted function of time	●	●	●
Profile editor	●	●	●
<b>Communications related functions</b>			
Ethernet	▲	▲	▲
DNC (DNC communications)	●	●	●
Telediagnosis	▲	▲	▲
Setup assistance	●	●	●
<b>Canned cycles</b>			
Machining canned cycles	●	●	-
Probing canned cycles	▲	▲	▲
Rigid tapping	▲	▲	▲

●● Standard    ▲▲ Option    - Not Available

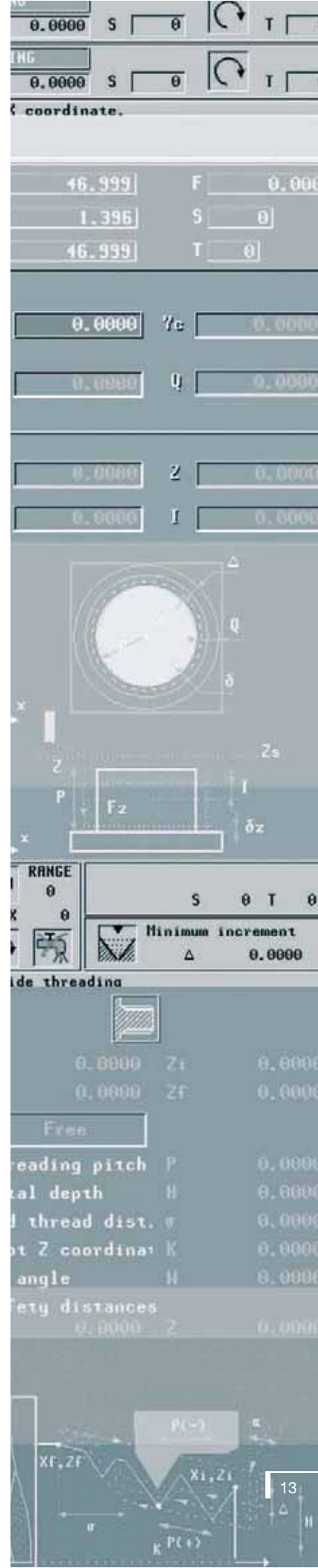

# Configuration CNC 8055

## Compact Configuration



Central Unit



Monitor (color) - Keyboard

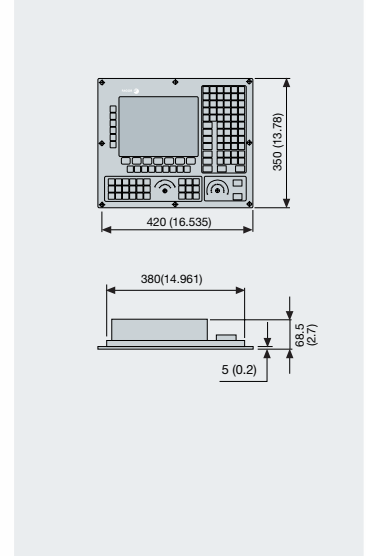
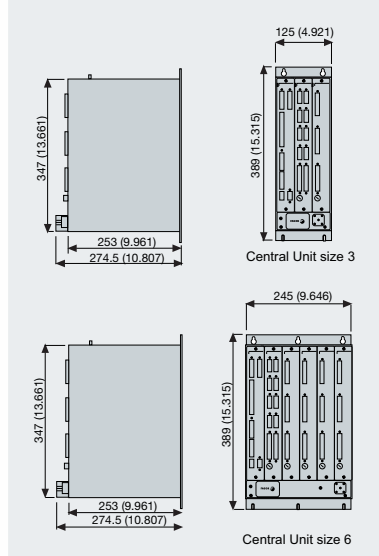

# Configuration CNC 8055-*i*



Central Unit - Monitor (color and monochrome) - Keyboard

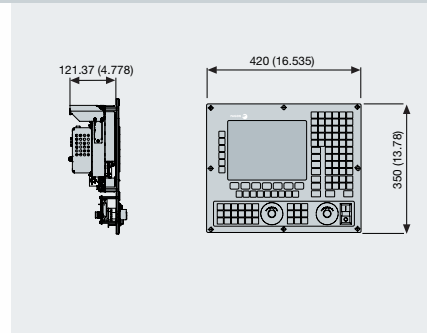

# Modular Configuration



**Central Unit**



**10,4" LCD Monitor (color)**



**Operator Panel**

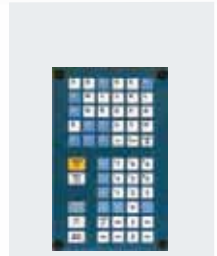

**Panel ISO (\*)**



**Keyboard switcher KS 50/55**

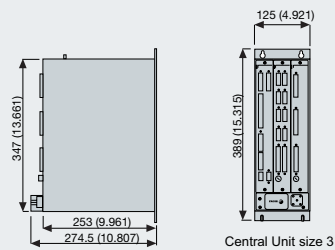

Central Unit size 3

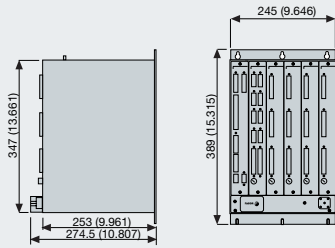

Central Unit size 6

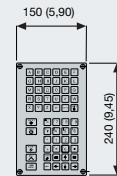
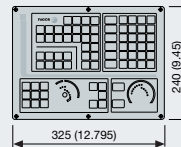
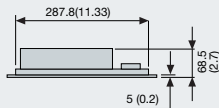
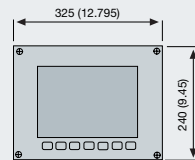

(\*) Requires keyboard switcher KS 50/55

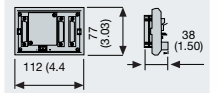

**Central Unit - Monitor (color)**



**Operator Panel**

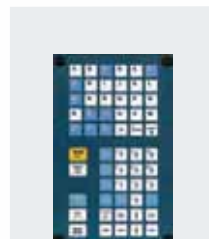

**Panel ISO (\*)**



**Keyboard switcher KS 50/55**

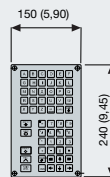
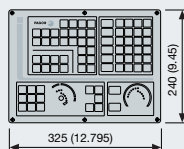
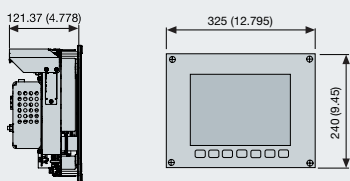

(\*) Requires keyboard switcher KS 50/55

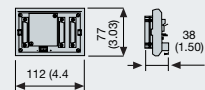

# Remote modules

These modules are easy to install, they are mounted at strategic points of the machine for having extra inputs and outputs distributed next to each device.

They are distributed in groups and are connected to the central unit through the CANopen bus. Modules of both series, RIO5 and RIOW, may be combined.



## RIO5 Series

Remote modules with CANopen protocol

**RIO5 PS-24I/16O**  
Header module with power supply, 24 digital inputs and 16 digital.

**RIO5 PS-2PT100/4AI/4AO**  
Header module with 4 analog inputs, 4 analog outputs and 2 inputs for PT100 temperature gages.

**RIO5 24I/16O EXP MOD**  
Expansion module with 24 digital inputs and 16 digital outputs.

**RIO5 48I/32O EXP MOD**  
Expansion module with 48 digital inputs and 32 digital outputs.

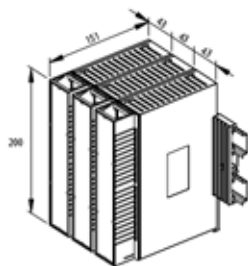

## Remote modules



## RIOW Series

Small remote modules with CANopen protocol

**RIOW CANOPEN-51205056**  
Header module CANopen.

**RIOW 8DI-51205053**  
Expansion module with 8 digital inputs.

**RIOW 8DO-51205043**  
Expansion module with 8 digital outputs.

**RIOW 4AI-51205050**  
Expansion module with 4 analog inputs.

**RIOW 4AO-51205039**  
Expansion module with 4 analog outputs.

**RIOW 2AI PT100-51205048**  
Expansion module with 2 inputs for PT100 temperature gages.

**RIOW PS24-51205036**  
24 V DC 10 A power supply for the modules.

**RIOW SSI-51205057**  
Feedback modules with SSI interface.

**RIOW TTL-51205116**  
Feedback module with 32-bit incremental TTL interface.

**RIOW END-51205037**  
Line terminating module. It must be present in all the configurations.

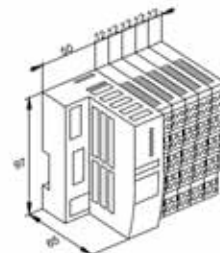



# FAGOR AUTOMATION, state-of-the-art technology

## Modular servo drive system

It is configured with power supply modules that may be connected directly to mains and with specific drive modules to govern axis and spindle motors.

- Non-regenerative power supplies (PS)
- Regenerative power supplies (XPS, RPS)
- Axis drives (AXD)
- Spindle drives (SPD)



## Compact servo drive system

Independent drive with integrated power supply. They may be connected directly to mains.

- Axis drives (ACD, ACSD, MCS)
- Spindle drives (SCD)



## Spindle motors

Small asynchronous motors balanced for high speed. They cover a power range between 3.7 Kw and 60 Kw with very low noise and vibration levels.

- FM7 E01 speeds of up to 9,000 rpm.
- FM7 E03 speeds of up to 15,000 rpm. Dual winding, Y/Delta (star/triangle)
- FM7 HS3 speeds of up to 15,000 rpm. Direct drive with a hole in the shaft for tool cooling.



## Axis motors

Synchronous motors with speeds of 3,000, 4,000, 4,500 and 6,000 rpm and a stall torque from 1.7 Nm to 76.6 Nm.



## Linear feedback systems

High performance, incremental linear encoders with measuring lengths between 0.070 m and 30 m, 0.1µm resolution and 3 µm accuracy. They use TDMS (Thermally determined mounting system) that prevents measuring errors due to temperature changes. General characteristics: Vibration: 20g, impact: 30g, speed: 120 m/min.



FAGOR AUTOMATION shall not be held responsible for any printing or transcribing errors in this catalog and reserves the right to make any changes to the characteristics of its products without prior notice.

**Fagor Automation S. Coop.**  
B° San Andrés, 19 – P.O.Box 144  
E-20500 Arrasate-Mondragón, Spain  
Tel. 34 943 719 200  
34 943 039 800  
Fax: 34 943 791 712  
E-mail: info@fagorautomation.es  
www.fagorautomation.com



## EUROPE

- DE - Fagor Automation GmbH (Göppingen)**  
Tel. 49 7161 15 6850 Fax: 49 7161 15 685 79
- ES - Fagor Automation Catalunya (Barcelona)**  
Tel. 34 934 744 375 Fax: 34 934 744 327
- FR - Fagor Automation France S.à.r.l. (Clermont Ferrand)**  
Tel. 33 473 277 916 Fax: 33 473 150 289
- GB - Fagor Automation UK Ltd. (West Midlands)**  
Tel. 44 1327 300 067 Fax: 44 1327 300 880
- IT - Fagor Italia S.R.L. (Milano)**  
Tel. 39 0295 301 290 Fax: 39 0295 301 298
- PO - Fagor Automation Ltda. (Leça da Palmeira)**  
Tel. 351 229 968 865 Fax: 351 229 960 719
- RU - Fagor Automation Russia. (Moscow)**  
Tel. 7 926 795 29 12

## AMERICA

- BR - Fagor Automation do Brasil Com. Imp. Exp. Ltda. (São Paulo)**  
Tel. 55 11 56 94 08 22 Fax: 55 11 56 81 62 71
- CA - Fagor Automation Ontario (Mississauga)**  
Tel. 1 905 670 74 48 Fax: 1 905 670 74 49
- Fagor Automation Quebec (Montreal)**  
Tel. 1 450 227 05 88 Fax: 1 450 227 61 32
- Fagor Automation Windsor (Canada)**  
Tel. 1 519 944 56 74 Fax: 1 519 944 23 69
- US - Fagor Automation Corp. (Chicago)**  
Tel. 1 847 98 11 500 Fax: 1 847 98 11 311
- Fagor Automation West Coast (California)**  
Tel. 1 714 957 98 85 Fax: 1 714 957 98 91
- Fagor Automation East Coast (New Jersey)**  
Tel. 1 973 773 35 25 Fax: 1 973 773 35 26
- Fagor Automation Ohio Branch (Ohio)**  
Tel. 1 614 855 5720 Fax: 1 614 855 5928
- Fagor Automation South East (Florida)**  
Tel. 1 813 654 45 99 Fax: 1 813 654 3387

## ASIA

- CN - Beijing Fagor Automation Equipment Co., Ltd. (Beijing)**  
Tel. 86 10 84505858 Fax: 86 10 84505860
- Beijing Fagor Automation Equipment Ltd. (Nanjing)**  
Tel. 86 25 83 32 82 59 Fax: 86 25 83 32 82 60
- Beijing Fagor Automation Equipment Ltd. (Chengdu)**  
Tel. 86 28 66 13 20 81 Fax: 86 28 66 13 20 82
- Beijing Fagor Automation Equipment Co., Ltd. (Guangzhou)**  
Tel. 86 20 86 55 31 24 Fax: 86 20 86 55 31 25
- Beijing Fagor Automation Equipment Co., Ltd. (Shanghai)**  
Tel. 86 21 63 53 90 07 Fax: 86 21 63 53 88 40
- HK - Fagor Automation (Asia) Ltd., ( Hong Kong)**  
Tel. 852 23 89 16 63 Fax: 852 23 89 50 86
- IN - Fagor Control System Pvt. Ltd. (Bangalore)**  
Tel. +91 (0)8042682828 Fax: +91 (0)8042682816
- KR - Fagor Automation Korea, Ltd. (Seoul)**  
Tel. 82 2 21 13 03 41 / 2113 0342 Fax: 82 2 21 13 03 43
- MY - Fagor Automation (M) SDN.BHD. (Kuala Lumpur)**  
Tel. 60 3 8062 2858 Fax: 60 3 8062 3858
- SG - Fagor Automation (S) Pte. Ltd. (Singapore)**  
Tel. 65 68417345 / 68417346 Fax: 65 68417348
- TW - Fagor Automation Taiwan Co. Ltd. (Taichung)**  
Tel. 886 4 2 385 1558 Fax: 886 4 2 385 1598

Fagor Automation holds the ISO 9001 Quality System Certificate and the CE Certificate for all its products.



**FAGOR**  
FAGOR AUTOMATION

Worldwide reliability